



## Border

Dit uit roestvrij staal vervaardigd systeem verzekert u van een optimale bevestiging.

Door zijn eenvoud bespaart u kostbare tijd bij het plaatsen. En doordat er al miljoenen m<sup>2</sup> aan planken mee uitgerust werden en het uitgetest werd in combinatie met tal van natuurlijke en synthetische soorten van

planken, vormt het de ideale partner voor uw terrassen en gevelbekleding.



### Eigenschappen

-  **onzichtbare bevestiging van de eerste en laatste planken**
-  **hoge afwerkingsgraad, onzichtbaar op alle planken**
-  **eenvoudige en snelle montage: 40% tijdswinst**
-  **oog voor de bewegingen van het hout: «veereffect»**
-  **plaatselijke demontage mogelijk**
-  **bruikbaar op 3 verschillende profielen**
-  **zowel voor de montage van terrassen als van gevelbekleding**
-  **verstevigde, zelfborende schroef in roestvrij staal**
-  **goedgekeurd door specialisten**
-  **gepatenteerd systeem**
-  **Belgische productie**

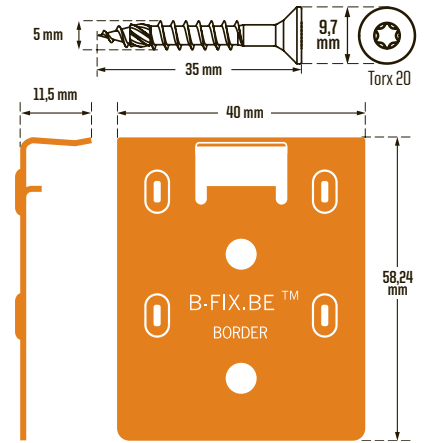
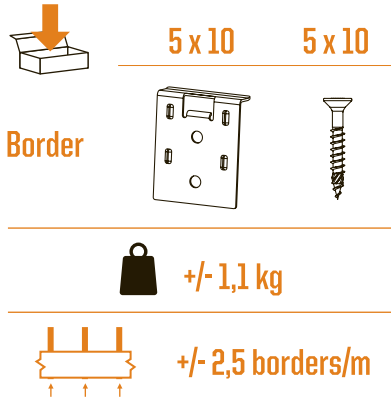

## Profielen

3 compatibele profielen



B-Fix Classic



B-Fix Plus



B-Fix Premium



## Aanbevolen materiaal

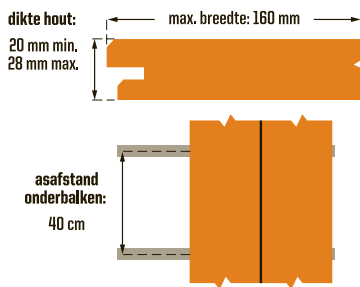

## Vingerlassing

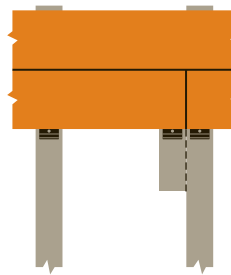

## Materiaal



B-Fix Border: roestvrij staal 301

B-Schroef Border: roestvrij staal A2  
+ zilvere coating

## Montage

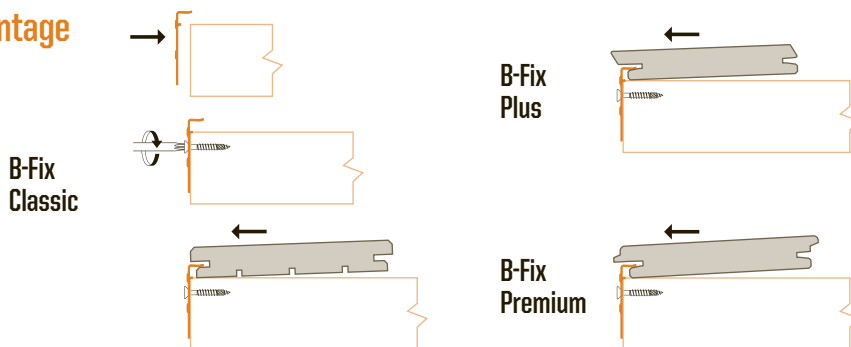

## Onderbalken

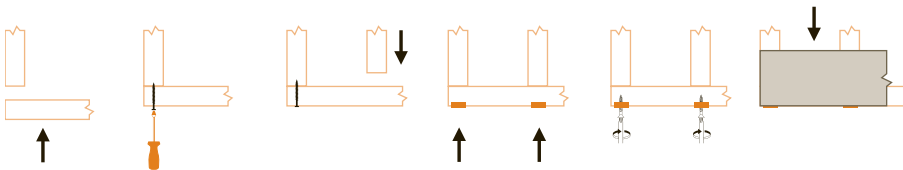

## Geteste houtsoorten



Ipé, Padouk, Afrormosia,  
Cumaru, Itauba, Tali, Limbali, Lariks,  
Douglas, Bamboe, Teak, Jatoba, Merbau,  
Garapa, Massaranduba, thermo hout,  
composiet, Accoya, ...

## Plaatsingsomstandigheden



Ideale vochtigheidsgraad

	Het Zoute	Brussel	Rijsel	Marseille
☀️	22	22	22	17
❄️	18	16	14	11
	<u>2</u>	<u>2</u>	<u>2</u>	<u>2</u>
	= 20%	= 19%	= 18%	= 14%

Verdeeld door:

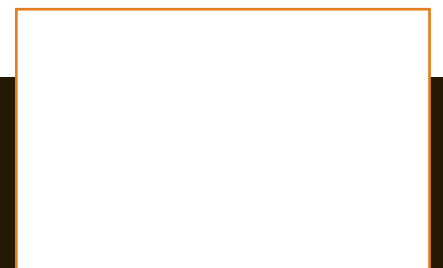

+32 10 400 790  
+33 1 747 13 834  
+32 10 400 795  
+33 1 747 13 835

✉️ info@b-fix.be  
📍 Drève des 4 Chênes, 1  
B-1495 Villers-la-Ville  
🌐 www.b-fix.be